

FS-GLO+ insert compatible with Gloomhaven: Forgotten Circles® expansion



Assembly Instructions

The package contains 3 sheets, two of them are identical plus one different sheet.

After assembly the trays are put in two layers in the original game box.

Ordinary PVA glue is required when assembling each tray.

Please make sure you dry-assemble each tray correctly before gluing it together.

Please check www.foldedspace.net for general assembly tips.

FS-GLO+

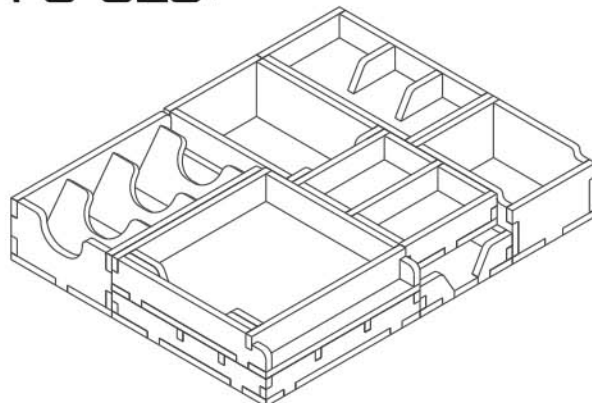

Sheet A1

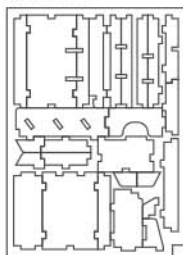

Sheet A2

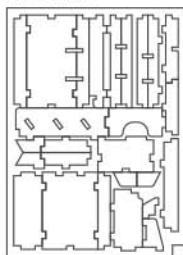

Sheet B1

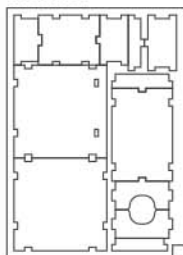

Tray 1

Sheet A1, A2

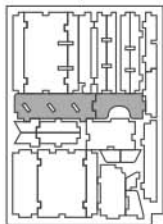

Sheet B1

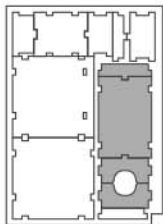

Step 1

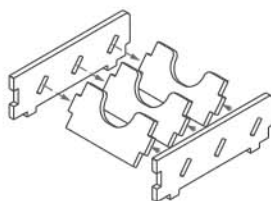

Step 2

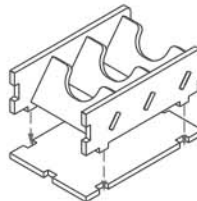

Step 3

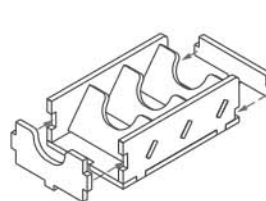

Finished tray

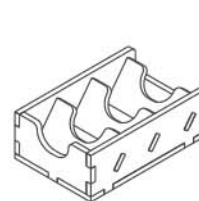

Tray 2a & 2b (the trays are identical)

Sheet A1

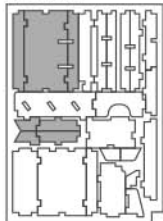

Sheet A2

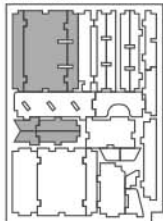

Step 1

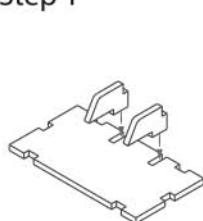

Step 2

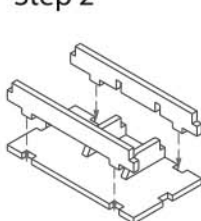

Step 3

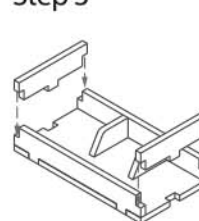

Finished tray

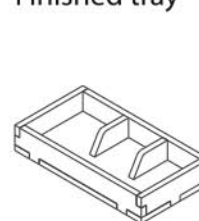

Tray 3

Sheet A1, A2

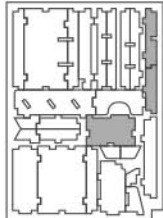

Sheet B1

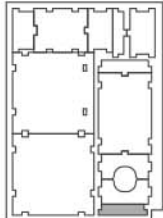

Step 1

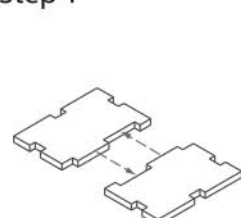

Step 2

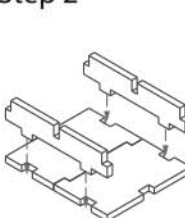

Step 3

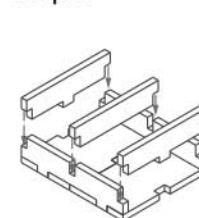

Finished tray

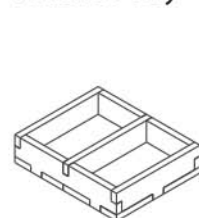

Tray 4

Sheet A1, A2

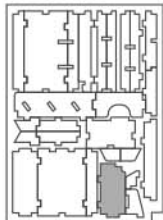

Sheet B1

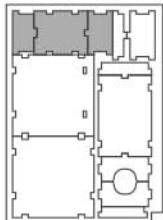

Step 1

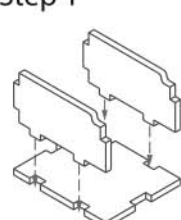

Step 2

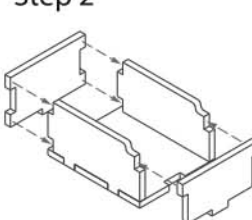

Finished tray

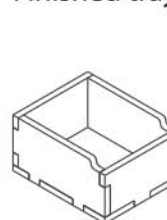

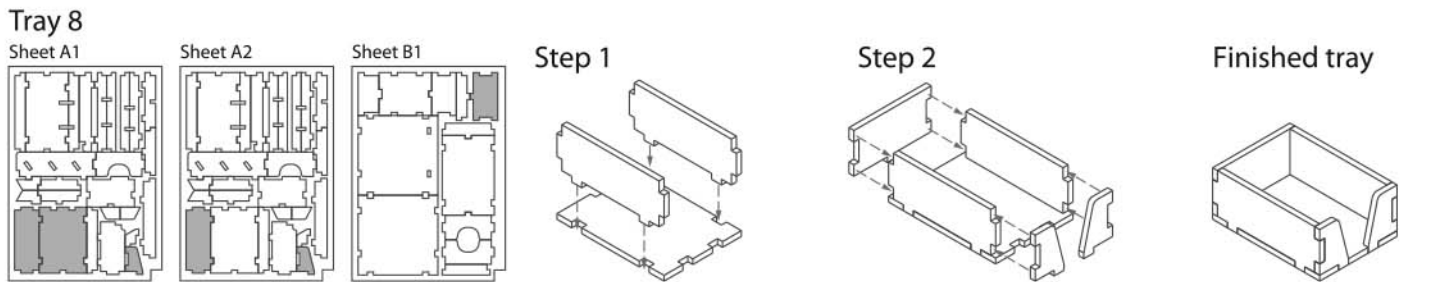
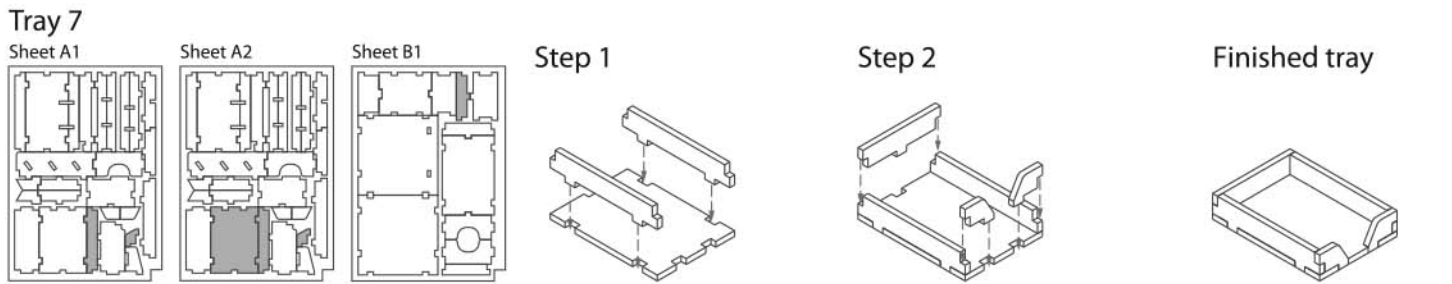
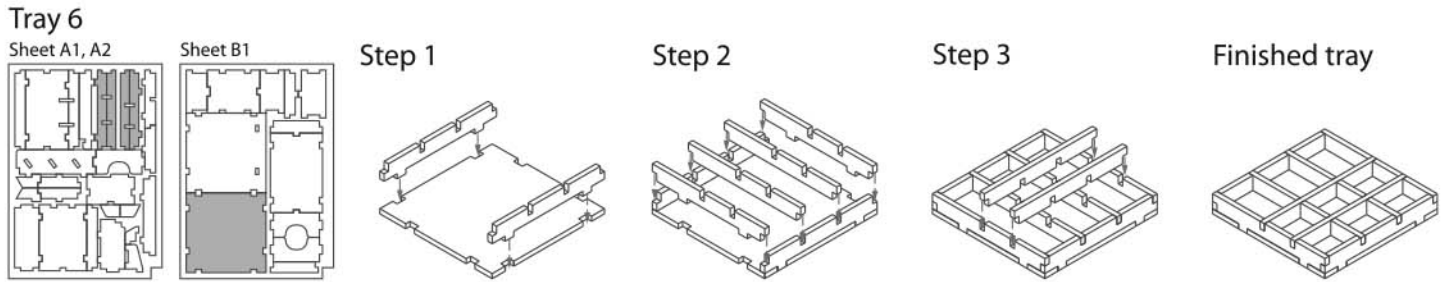
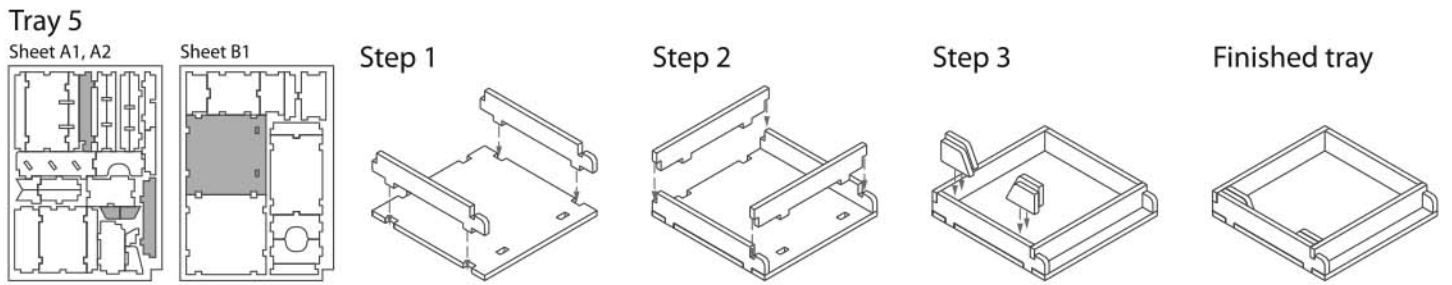

FS-GLO+

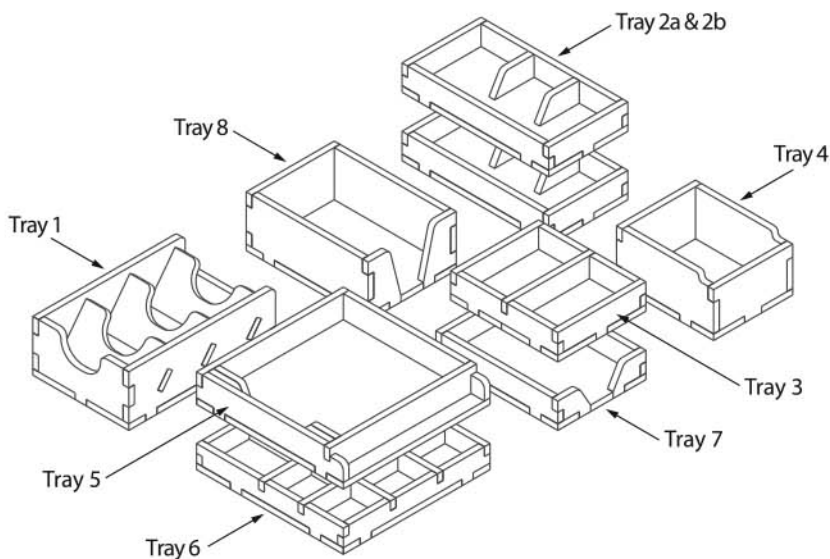

Please check www.foldedspace.net for photos of this insert in use.

Tray legend:

- Tray 1 - small cards
- Tray 2a, b - medium monster standees
- Tray 3 - rift overlay tiles, plus other terrain tiles from main game
- Tray 4 - miniature in box & plastic stands
- Tray 5 - monster stat sheets & sleeves
- Tray 6 - condition tokens, plus status tokens sorted by type from main game
- Tray 7, 8 - large cards

Note: the character tuck box for the Diviner should be added to the main game box together with the other tuck boxes.

FS-GLO+ is intended to compliment the main FS-GLO insert for the Gloomhaven game box. Please feel free to mix and match how trays are used in both inserts to get your own the optimum storage arrangement.