

Assembly Instructions

The package contains 4 sheets, two of them are identical to the other two.

After assembly the trays are put in two layers in the original game box.

Ordinary PVA glue is required when assembling each tray, for extra strength.

Please make sure you dry-assemble each tray correctly before gluing it together.

Please check www.foldedspace.net for general assembly tips.

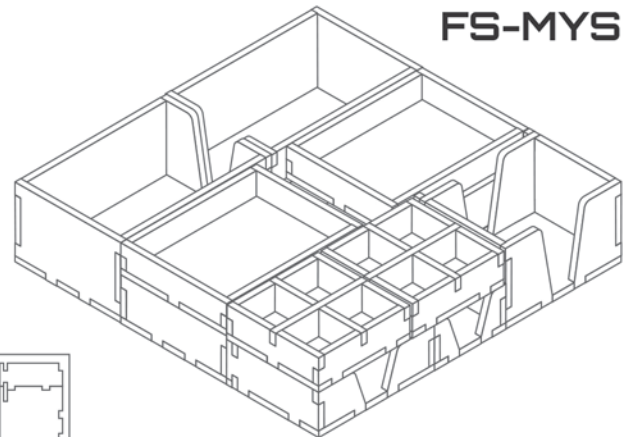

FS-MYS

Sheet A

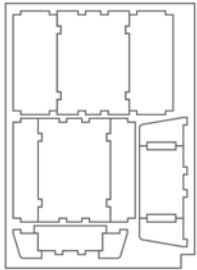

Sheet B

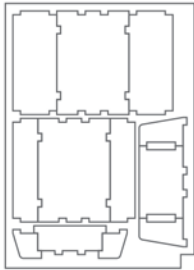

Sheet C

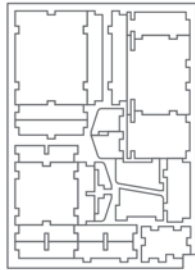

Sheet D

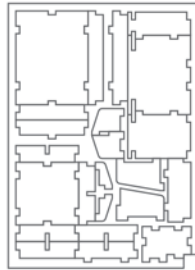

Tray 1a & 1b (the trays are identical)

Sheet A

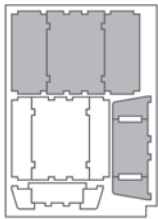

Sheet B

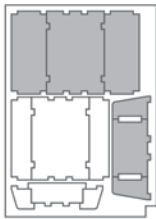

Step 1

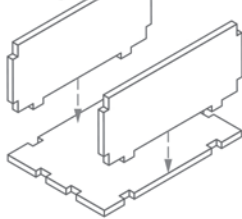

Step 2

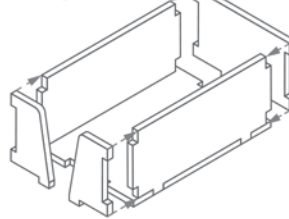

Finished tray

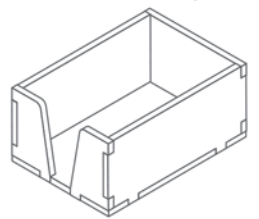

Tray 2a & 2b (the trays are identical)

Sheet A

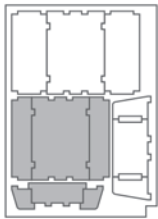

Sheet B

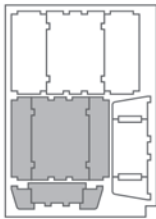

Step 1

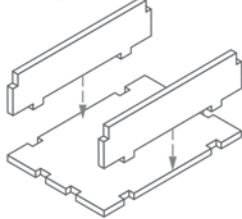

Step 2

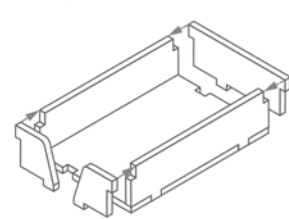

Finished tray

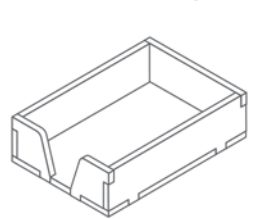

Tray 3a & 3b (the trays are identical)

Sheet C



Sheet D



Step 1

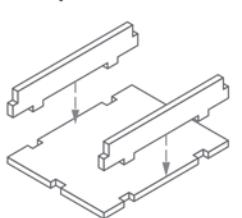

Step 2

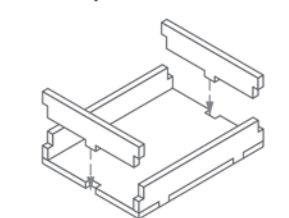

Finished tray

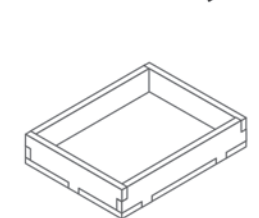

Tray 4a & 4b (the trays are identical)

Sheet C



Sheet D



Step 1

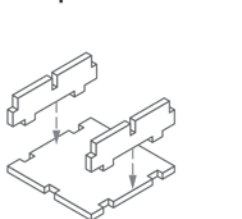

Step 2

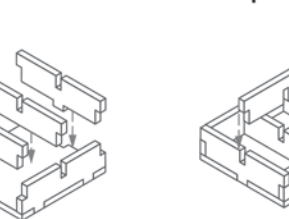

Step 3

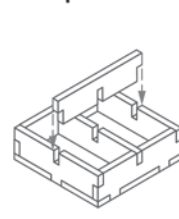

Finished tray

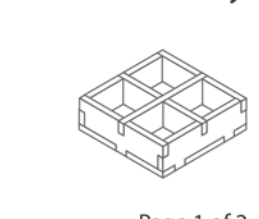

Tray 5

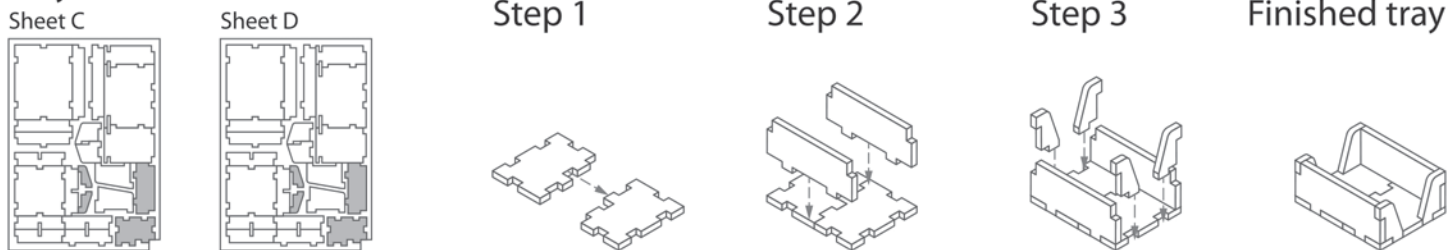

Tray 6

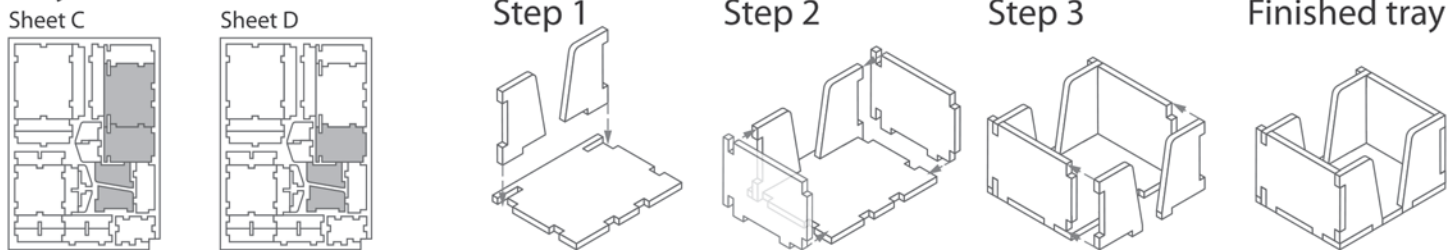

Tray 7

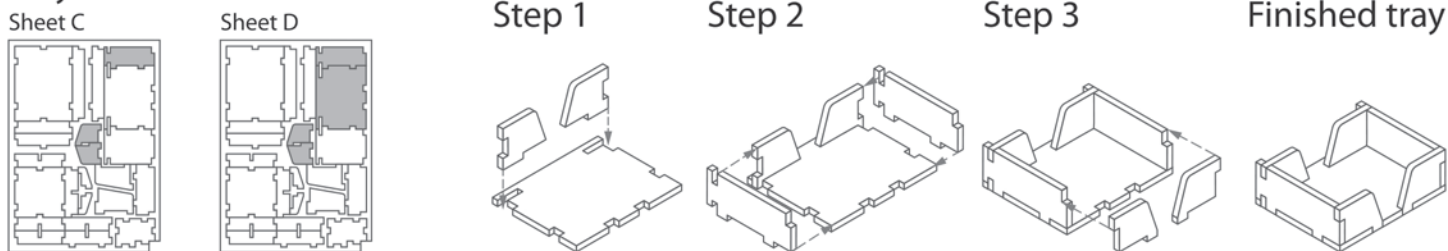

FS-MYS

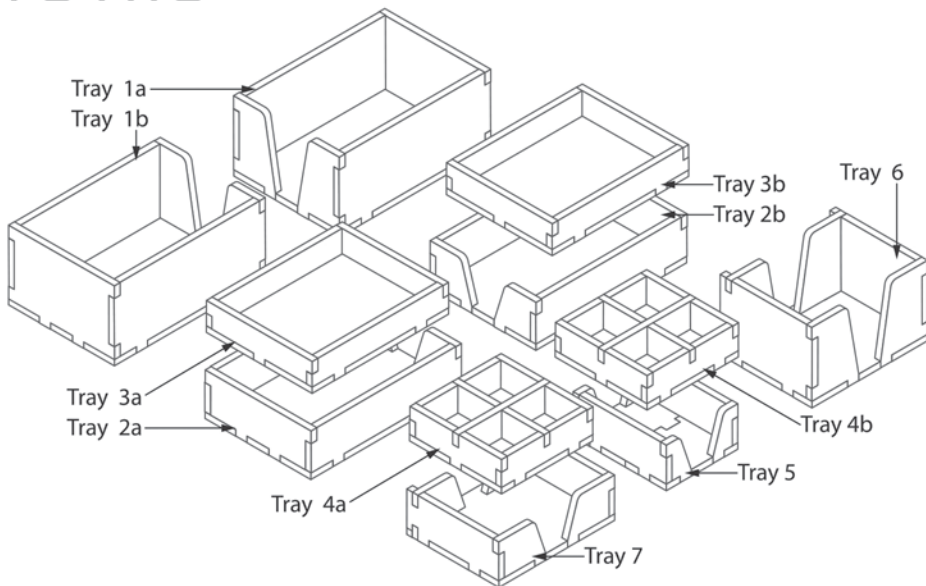

Please check www.foldedspace.net for photos of this insert in use.

Tray legend:

- Tray 1a, b - vision cards
- Tray 2a - character psychic cards
- Tray 2b - location psychic cards
- Tray 3a - crows and ghosts
- Tray 3b - psychic sleeves
- Tray 4a, b - player pieces
- Tray 5 - object psychic cards
- Tray 6 - location and object ghost cards
- Tray 7 - character ghost cards

Note: The clairvoyance track and epilogue progress board, together with the clock, go on top of the insert tray. The rules go on top of this. Please check our website for pictures: www.foldedspace.net